

VC120DG: User Guide

In the box:

SIMPLEFIX digital video camera

User Guide

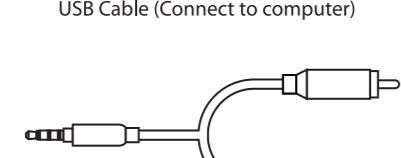
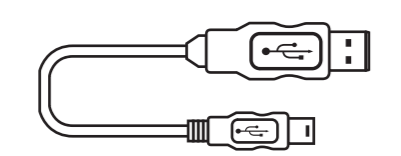
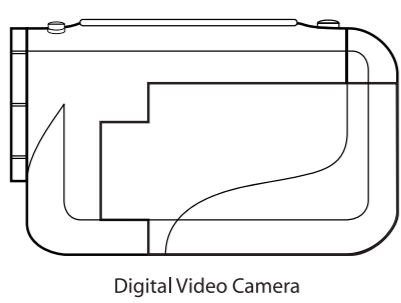

Setting up your camera:

Battery Installation

1. Open the battery cover by sliding it in the direction of the arrow.
2. Insert 3 alkaline "AAA" size batteries (not included) into the compartment.
3. Replace the battery cover.

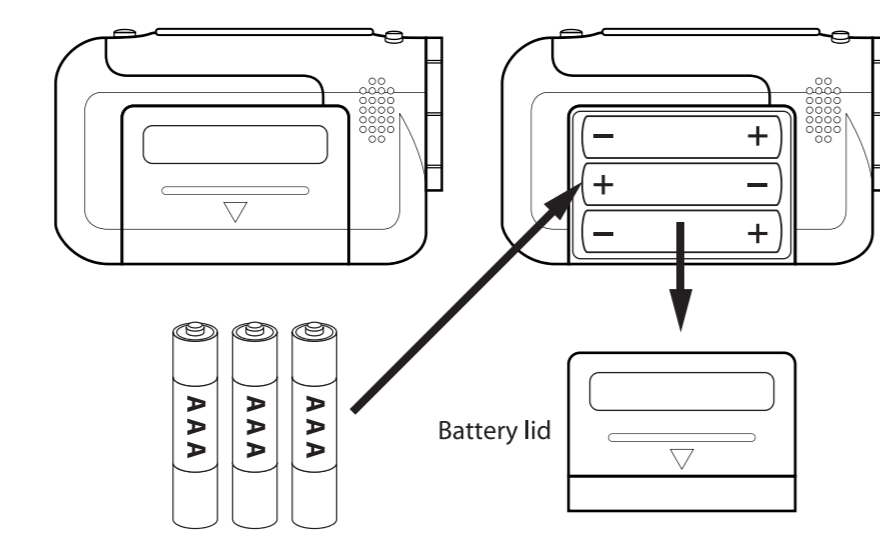

SD card Installation

This camera has no internal memory and requires an SD /SDHC card (1 GB SD card included) to record videos or take pictures. The camera can support SD /SDHC cards up to 4 GB. To install the SD card into the camera, follow the steps below:

1. Turn off the camera.
2. Insert the SD card into the slot (as shown below) until it clicks and locks into place.
3. To remove the card, gently push it out.

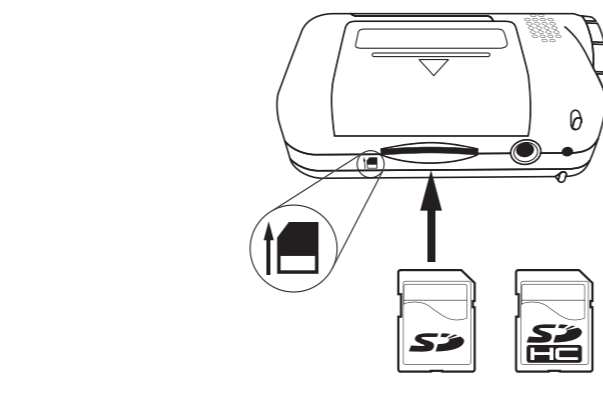

- A card can only be inserted one way; do not use force when inserting the card.
- Inserting or removing a card while the camera is on may damage the card, files stored on the card, or the camera.
- This camera supports SD or SDHC cards up to 4GB.

Using your camera

Turning the camera ON/OFF

1. Open the display screen.
2. To turn on the camera, press and HOLD the [ON] button until the display turns on.
3. To turn the camera off, press and HOLD the [OFF] button until the display turns off.

Setting the date/time

1. Turn on the camera.
2. Press the [OK] button, and use the [] button to select [T].
3. Use the [] button to scroll down to "Date & Time" and press the [] button.
4. Adjust the date and time and press the [OK] button.



Select and confirm options

Locations of controls

Connecting the tripod

Screw in and secure the included tripod to the bottom of the video camera as shown in the diagram.

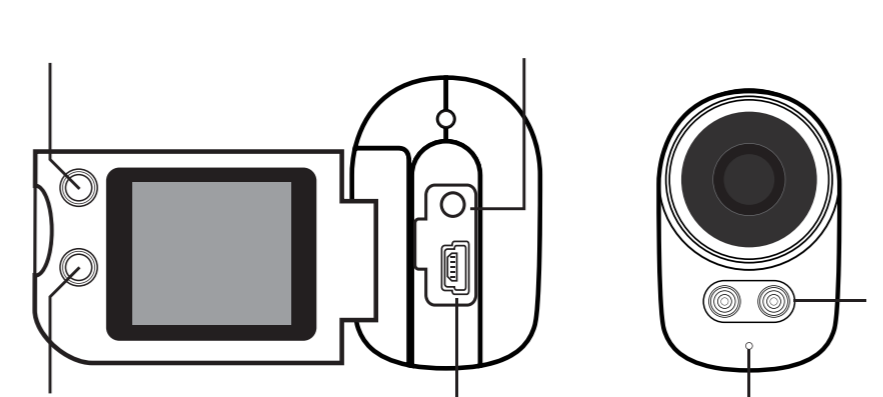
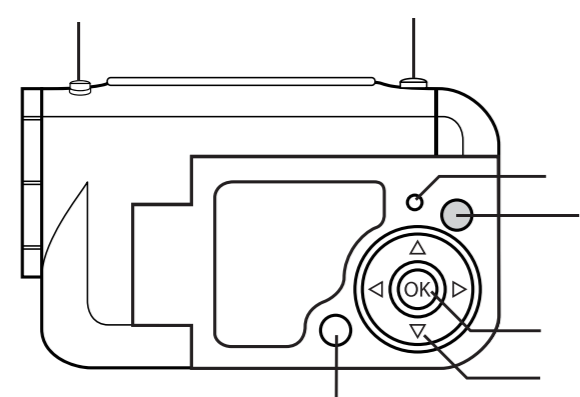

Camera modes

When you turn on the camera, the default mode is **Video Mode**. To scroll through and select one of the three camera modes below, press the [MODE] button until the desired mode is displayed.

Video Mode

1. Make sure that an SD card is inserted into the camera.
2. Turn on the camera, the **Standby Recording Screen** is displayed and the camera is in **Video Mode**.
3. Press the [RECORD] button, the **Recording Screen** is displayed and the camera is recording video (The recording indicator light is lit when recording).
4. To stop recording, press the [RECORD] button once again, and the display returns to the **Standby Recording Screen**.

Standby Recording Screen



1. Video Mode Icon
2. White Balance
3. Exposure Metering Mode
4. Pixels (Video)
5. Recording Time (Video)
6. SD card Indicator
7. Battery Status
8. Digital Zoom Indicator
9. LED Light (ON)

Picture Mode

1. Make sure that an SD card is inserted into the camera.
2. Turn on the camera, and press the [MODE] button once to enter the **Picture Mode** (the **Picture Mode Screen** is displayed).
3. Press the [RECORD] button to take a picture.

Picture Mode Screen

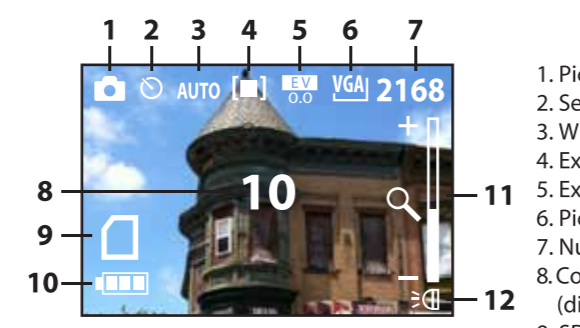

1. Picture Mode Icon
2. Self Timer (On)
3. White Balance
4. Exposure Metering Mode
5. Exposure Mode
6. Picture size (Image Quality)
7. Number of Photos that can be taken
8. Count Down for the Self Timer (displayed when the Self Timer is ON)
9. SD card Indicator
10. Battery Status
11. Digital Zoom Indicator
12. LED Light Status (On)

Playback Mode

1. Turn on the camera, and press the [MODE] button twice to enter the **Playback Mode**.
2. Press the [] or [] button to select a video or picture.
3. If you select a video, press the [RECORD] button to start or stop the playback.
4. Press the [MODE] button to return to the **Video Mode** or **Picture Mode**.

Video Playback Screen



1. Playback Mode Icon
2. Number of saved pictures & videos
3. File type (Video File)
4. File type (Picture File)

Picture Playback Screen



Macro shooting

To film or take pictures of objects up close (6" - 10") such as flowers insects etc., slide the [Macro] switch to the [] position.



Zoom

Use the [Q] or [Q] button to zoom in or out when recording video, and taking photos.

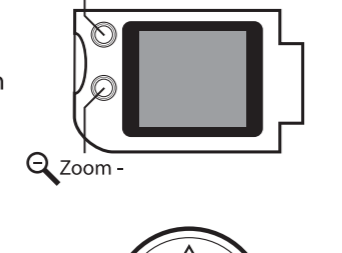

LED Light

Press the [] button to turn the LED light On or Off.



General shooting

For normal video or picture taking, slide the [Macro] switch back to the [] position.

Video Mode Settings

1. Press the [MODE] button until the **Video Mode** is selected.
2. Press the [OK] button to access the **Video Mode Settings Screen**.
3. Use the [] [] [] [] [] [] buttons to select an option, and confirm by pressing the [OK] button.
4. Press the [OK] button once again to exit the **Video Mode Settings Screen**.

Video Mode Settings Screen

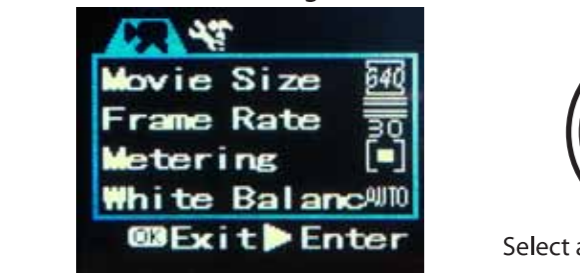

Select and confirm options

Picture Mode Settings

1. Press the [MODE] button until the **Picture Mode** is selected.
2. Press the [OK] button to access the **Picture Mode Settings Screen**.
3. Use the [] [] [] [] [] [] buttons to select an option, and confirm by pressing the [OK] button.
4. Press the [OK] button once again to exit the **Picture Mode Settings Screen**.

Picture Mode Settings Screen

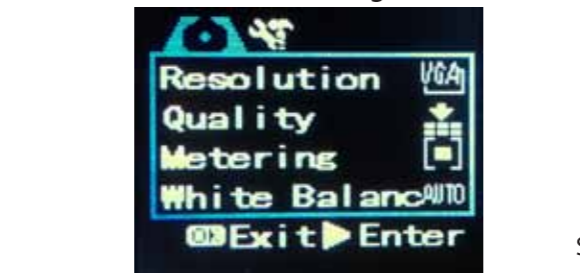

Select and confirm options

Playback Mode Settings

1. Press the [MODE] button until the **Playback Mode** is selected.
2. Press the [OK] button to access the **Playback Mode Settings Screen**.
3. Use the [] [] [] [] [] [] buttons to select an option, and confirm by pressing the [OK] button.
4. Press the [OK] button once again to exit the **Playback Mode Settings Screen**.

Playback Mode Settings Screen



Select and confirm options

System Settings Options

SOUND	On / Off
POWER FREQUENCY	50Hz / 60Hz (The camera's default setting is 60Hz for the USA and North America.)
POWER SAVE	Select 1, 3, or 5 minutes. To conserve battery power, the camera will shut off if no buttons are pressed within the selected time.
DATE & TIME	Set the date and time.
LANGUAGE	Select a display language.
TV OUT	PAL / NTSC (The camera's default setting is NTSC for the USA and North America.)
USB	MSDC OR PCCAM (Only select PCCAM when you would like to use the camera as a webcam.)
START-UP IMAGE	Change the start up image.
FORMAT	Format the SD / SDHC card (Deletes everything on the card).
RESET ALL	Reset the camera to factory default settings.

Video Mode Settings Options

MOVIE SIZE	• 640x480 (higher quality video/shorter recording time) • 320x240 (lower quality video/longer recording time)
FRAME RATE	• 30 Frames Per Second (higher quality video/shorter recording time) • 15 Frames Per Second (lower quality video/longer recording time)
METERING	• Center / Multi / Spot
WHITE BALANCE	• Auto / Daylight / Cloudy / Fluorescent / Tungsten

Picture Mode Settings Options

RESOLUTION	3M (2048x1536) / 1M (1280x1024) / (VGA) 640x480 (Higher picture resolution takes up more space on the card).
QUALITY	Superfine / Fine / Normal
METERING	Center / Multi / Spot
WHITE BALANCE	Auto / Daylight / Cloudy / Fluorescent / Tungsten
EXPOSURE	Adjust the exposure
DRIVER MODE	"Off" (disables the Picture Mode), "2" or "10" second options (use the Self Timer), "Burst"
EFFECT	Normal / B&W / Sepia / Negative / Red / Green / Blue

Playback Mode Settings Options

LOCK	Lock one or all of your picture and video files. When locked they will not be able to be deleted.
DELETE	"One" (Delete the currently displayed video or picture) or "All"
SLIDE SHOW	Start a slide show, and adjust the slide show settings
EFFECT	Select from various special effects
ROTATE	Rotate the picture
RESIZE	Resize the picture
VOICE MEMO	Record a voice memo, or delete a previously recorded voice memo.
START-UP IMAGE	Change the start up image.

Connecting the camera

Connecting your camera to a TV

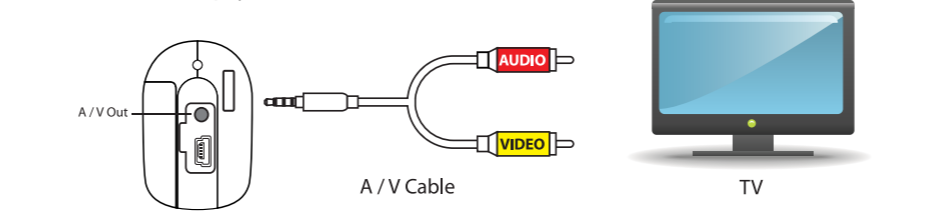

To enjoy and watch or view your videos and pictures on a television, please follow the instructions below:

1. Connect the black plug of the provided A / V Cable to your camera's A / V OUT Jack.
2. Connect the Red and Yellow plugs to your television's matching video (yellow) and audio (red or white) inputs.
3. Turn on the camera; the display will turn on briefly and shut, while the red LED indicator light will remain lit.
4. Click on your television's "Input" button until you see the live feed from the camera.
5. Press the [Mode] button twice to enter the **Playback Mode**.
6. Use the [] or [] button to select a video file, and press the [Record] button to begin or stop playback. Or select a JPG picture file and press the [OK] button and select "Slide Show" from the **Playback Mode Settings Screen**. Press the [] button and select "Start" to begin a slideshow of all the pictures stored on the camera's SD card.

Connect your camera to a computer

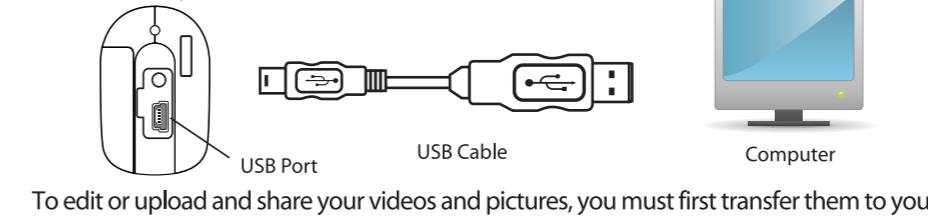

To edit or upload and share your videos and pictures, you must first transfer them to your computer. Follow the steps below to connect the camera to your computer, and use the provided Media Impression software to manage, view, edit and share your videos and pictures.

1. Make sure the camera is turned Off, and that an SD / SDHC card is inserted in the camera before connecting it to your computer.
2. Insert the smaller end of the USB cable into the camera's USB port.
3. Connect the larger end of the USB cable into your computer's USB port.
4. Turn ON the camera.
5. Look for your camera by clicking on My Computer, it should usually appear as "Removable Disk". Select a file on your camera, and simply move it into your computer (we recommend copying the files into the "My Videos" or "My Pictures" folder of your computer) in the usual way (drag-and-drop, copy-and-paste). Or open the Media Impression software, to easily locate your camera and transfer, view, edit, and upload your video and picture files (See "ArcSoft® Media Impression").
6. Before disconnecting the camera, click on the "Safely Remove Hardware" icon usually located on the lower right corner of your Desktop.

- Please do not disconnect the USB cable during loading, as it may cause damage to the camera and the files on the SD card.

ArcSoft® Media Impression

Installing

Install the included ArcSoft® Media Impression software before connecting the camera to your computer. With this software you will be able to manage, view, edit, transfer, and easily upload / share your videos and pictures. Follow the instructions below to install the Media Impression software onto your computer.



1. Insert the provided CD into the CD-ROM drive of your computer, and click on "ArcSoft® Media Impression".
2. Click "Install".
3. Click "Next" when prompted and "Finish".
4. To open Media Impression, click on the Media Impression icon on your Desktop.

Transferring videos and pictures from the camera to your computer

1. Open Media Impression.
2. Click "Import".
3. In the "Get Media from" drop down window, find your camera. (Usually displayed as "Removable Disk").

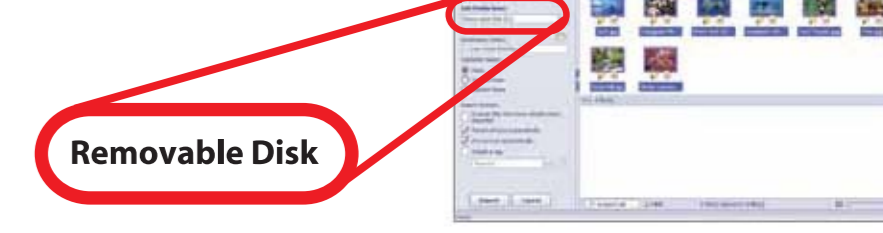

Viewing videos on your computer

1. From the Main Screen click on "Video".
2. Select a video and click on the Media Player icon.

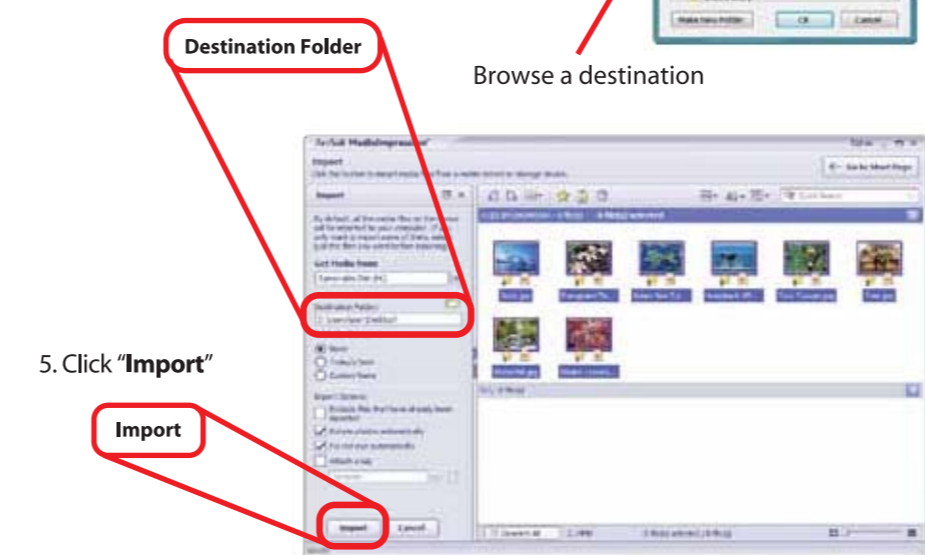

Viewing pictures on your computer

1. From the Main Screen click on "Video".
2. Select a picture, and click on the "Photo Viewer" icon.

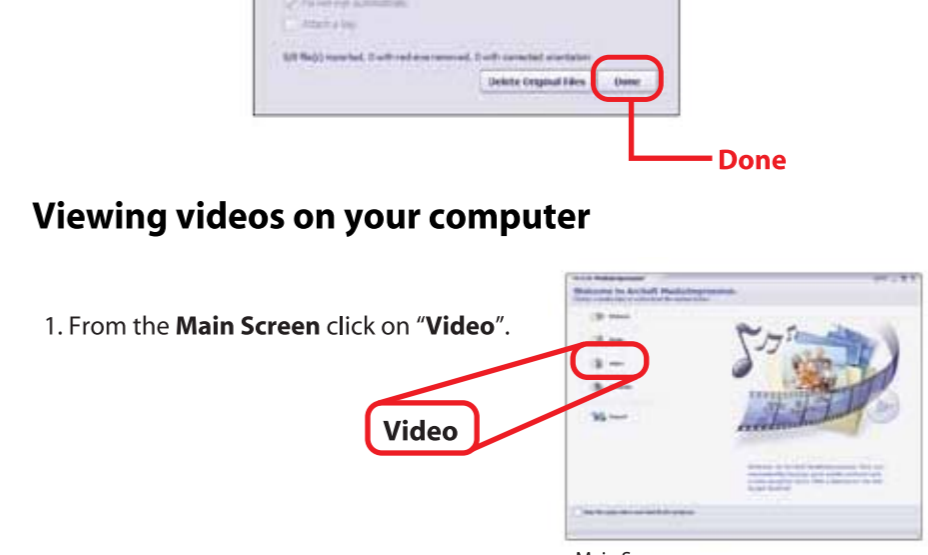

Uploading videos to YouTube™

1. From the Main Screen click on "Video".
2. Select a video.
3. Click on the YouTube™ icon.

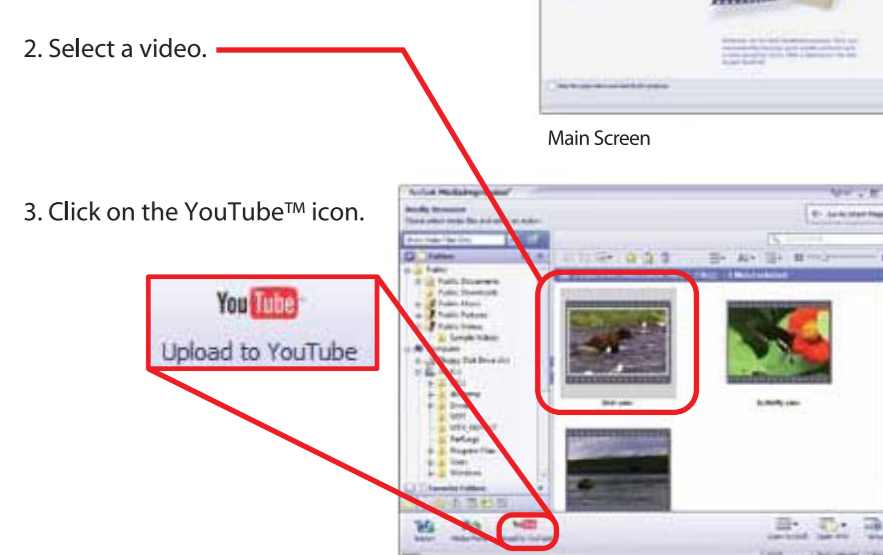

Camera modes

Video Mode

Picture Mode

Playback Mode

Using your camera as a webcam

1. Turn on the camera, and press the [MODE] button twice to enter the **Playback Mode**.
2. Press the [] or [] button to select a video or picture.
3. If you select a video, press the [RECORD] button to start or stop the playback.
4. Press the [MODE] button to return to the **Video Mode** or **Picture Mode**.

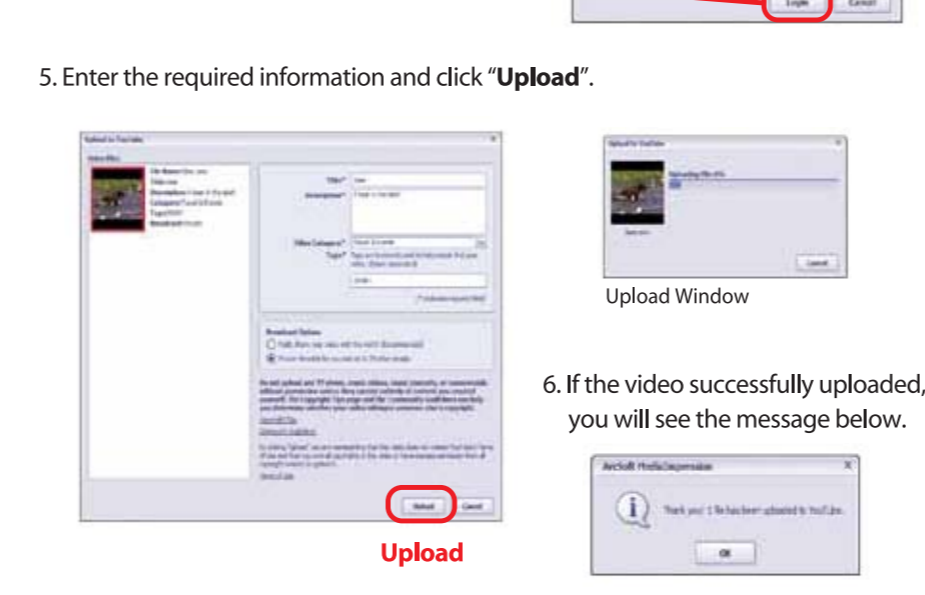

Web Chatting

1. Turn on the camera, and press the [OK] button.
2. Press the [] button and select [T] to enter the **System Settings Screen**.
3. Use the [] button to scroll down to "USB" and press the [] button.
4. Select "PCCAM" and press the [OK] button.
5. Press the [OK] button once again to exit the **System Settings Screen**.
6. When you connect the camera, it will be recognized by your computer as a webcam.

- We recommend using the included mini tripod when using your camera as a webcam.
- When you set the camera to PCCAM, you will not be able to access the files on the SD card when connecting the camera to your computer. Make sure to set it back to the default setting by selecting "USB" and then "MSDC" in System Settings.

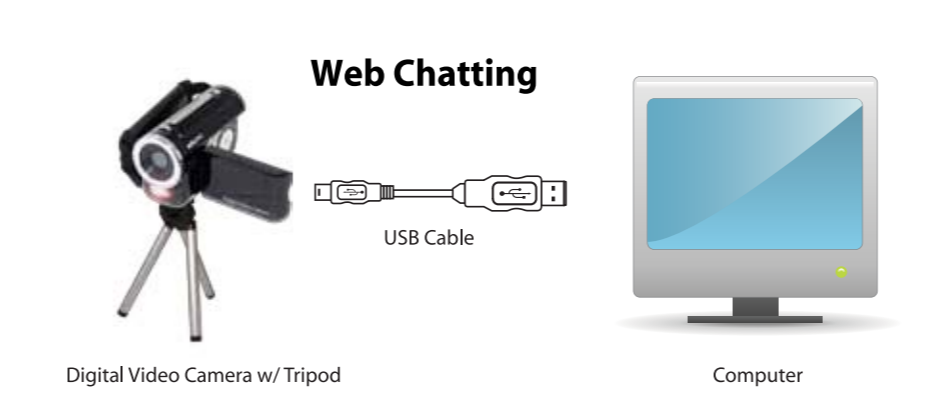

Safety Precautions

- Always follow these basic safety precautions when using your camera. This will reduce the risk of product damage and personal injury.
- Do not disassemble, repair or modify the camera by yourself. Refer servicing to qualified personnel.
 - If the LCD display breaks, do not touch the glass or liquid, and contact customer support.
 - The use of a NON-RECOMMENDED accessory may cause fire, electric shock, or injury. For approved accessories, please contact customer support.
 - Keep the camera away from direct sunlight and any direct heat source.
 - Do not expose the camera to rain or moisture.
 - Avoid using the camera in dry environments to avoid static.
 - Never apply heavy impact on the camera, or place it on a magnet.
 - When connecting the camera to a computer or TV, route the cable so that people and pets are not likely to trip over it.
 - Clean only with a dry cloth. Make sure the camera is turned off before cleaning. Do not use a liquid cleaner.
- Important Battery Precautions**
- Use only the type of battery specified in this user manual.
 - Batteries may present a risk of fire, explosion, or chemical burn if abused. Do not try to charge a battery that is not intended to be recharged.
 - Do not dispose of the battery (ies) in a fire. They may explode. Check with local codes for disposal instructions.
 - Non-rechargeable batteries, such as alkaline batteries, may leak if left in your product for a long period of time. Remove the batteries from the product if you are not going to use it for a month or longer.
 - If your product uses more than one battery, do not mix different types of batteries. Make sure you replace the old with all new batteries. Mixing different types of batteries or inserting them incorrectly may cause them to leak.
 - In the event that the battery is leaking do not handle the device with your bare hands. Contact the service center for help since the liquid may remain in the player if your body or clothes had contact with the battery liquid wash it off thoroughly with water. Also if some liquid gets into your eyes, do not rub your eyes but immediately wash them with clean water and consult a doctor.
 - Please help to protect the environment by recycling or disposing of batteries according to federal, state, and local regulations.

Warranty information

Limited Warranty

In the unlikely event that this product is defective, or does not perform properly, you may within **90 days** from your original date of purchase return it to the authorized service center for repair or exchange.

- The use of a NON-RECOMMENDED accessory may cause fire, electric shock, or injury. For approved accessories, please contact customer support.
- Do not expose the camera to rain or moisture.
- Avoid using the camera in dry environments to avoid static.
- Never apply heavy impact on the camera, or place it on a magnet.
- When connecting the camera to a computer or TV, route the cable so that people and pets are not likely to trip over it.
- Clean only with a dry cloth. Make sure the camera is turned off before cleaning. Do not use a liquid cleaner.

Important Battery Precautions

- Use only the type of battery specified in this user manual.
- Batteries may present a risk of fire, explosion, or chemical burn if abused. Do not try to charge a battery that is not intended to be recharged.
- Do not dispose of the battery (ies) in a fire. They may explode. Check with local codes for disposal instructions.
- Non-rechargeable batteries, such as alkaline batteries, may leak if left in your product for a long period of time. Remove the batteries from the product if you are not going to use it for a month or longer.
- If your product uses more than one battery, do not mix different types of batteries. Make sure you replace the old with all new batteries. Mixing different types of batteries or inserting them incorrectly may cause them to leak.
- In the event that the battery is leaking do not handle the device with your bare hands. Contact the service center for help since the liquid may remain in the player if your body or clothes had contact with the battery liquid wash it off thoroughly with water. Also if some liquid gets into your eyes, do not rub your eyes but immediately wash them with clean water and consult a doctor.
- Please help to protect the environment by recycling or disposing of batteries according to federal, state, and local regulations.

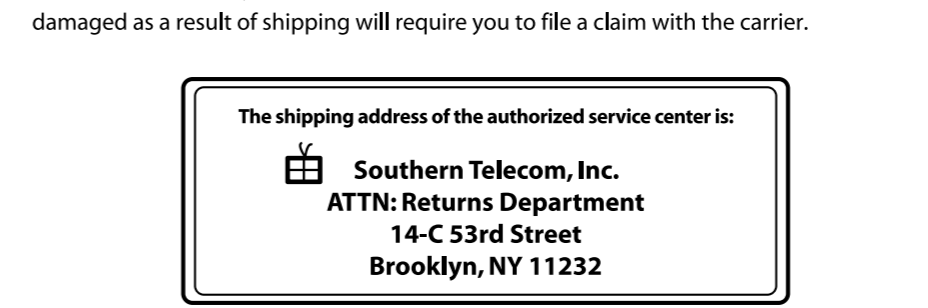

Trouble Shooting

- Camera will not turn on**
 - Check that the batteries are properly inserted.
 - Try replacing the batteries.
- The display does not light up, or the message "No Card!" is displayed**
 - Check that the SD card is properly inserted into the card slot.
- My videos / pictures are fuzzy or poor quality**
 - Try adjusting the "Movie Size" and "Frame Rate" from the **Video Mode Settings Screen** or the "Resolution" and "Quality" from the **Picture Mode Settings Screen**. Remember that choosing higher quality settings will take up more space on the memory card.
 - Make sure to keep the camera steady when filming, and be aware of the lighting environment (the more light the better your pictures and videos will turn out).
 - Make sure the [Macro] switch is set to [] for general shooting.
 - Avoid using the zoom too much, as it will affect the quality of your video and pictures.
 - Clean the lens of your camera, and make sure it is free of fingerprints (Clean only with a non abrasive dry cloth and make sure the player is turned off before cleaning).
- My videos are jumpy or shaky**
 - Use the included mini tripod.
 - Adjust the video / picture quality to a higher setting.

- My computer does not recognize the camera when I connect it to the USB port**
 - Check the connection of the USB cable, make sure it is properly connected.
 - If you recently used the webcam feature, you must go to the **System Settings Screen** and select "USB" and then "MSDC" option.

Still having trouble with your camera? Please call or email customer support:

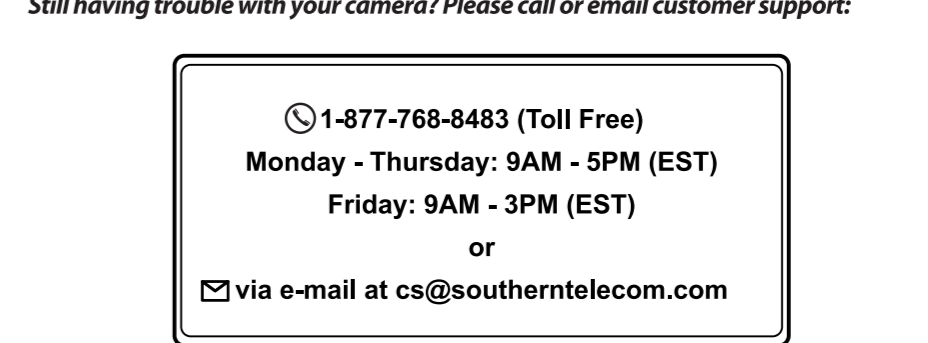

Webcam feature

Your Digital Video Camera may also be used as a webcam. This feature is quite useful if you would like to utilize the video function on Skype™ and other similar applications. To use the camera as a webcam you must first install the **WebCam Driver**. Follow the instructions below to install the driver and use the webcam feature.

1. Insert the provided CD into the CD-ROM drive of your computer, and click on "WebCam Driver".
2. Click "Next".
3. Click "Install" and "Finish" when prompted.

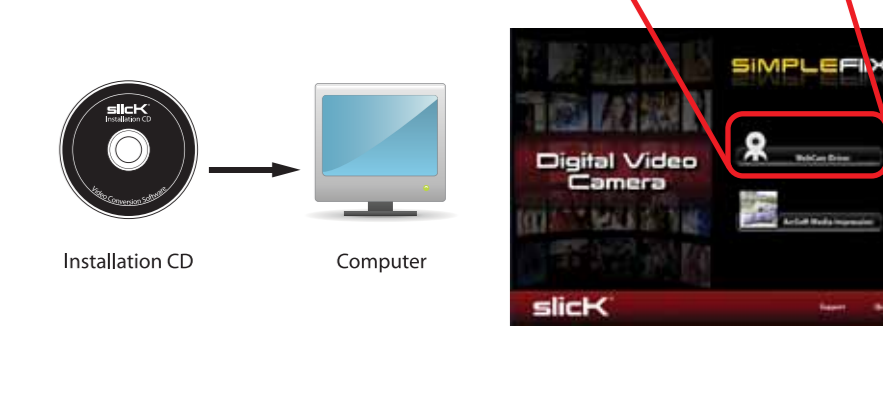

FCC information

FCC Part 15
This equipment has been tested and found to comply with the requirements for a Class B digital device under Part 15 of the Federal Communications Commission (FCC) rules. These requirements are intended to provide reasonable protection against harmful interference in a residential installation. This equipment generates, uses and can radiate radio frequency energy and, if not installed and used in accordance with the instructions, may cause harmful interference to radio communications. However, there is no guarantee that interference will not occur in a particular installation. If this equipment does cause harmful interference to radio or television reception, which can be determined by turning the equipment off and on, the user is encouraged to try to correct the interference by one or more of the following measures:

- Re-orient or relocate the receiving antenna.
- Increase the separation between the equipment and receiver.
- Connect the equipment to an outlet on a circuit different from that to which the receiver is connected.
- Consult the dealer or an experienced radio/TV technician for help.

Do not attempt to repair or modify this equipment.
Warning: Changes or modifications to this equipment not expressly approved by the party responsible for compliance could void the user's authority to operate the equipment.

Made in China / Designed in the USA
Manufactured by: Southern Telecom, Inc. Brooklyn, NY 11232
© 2009 Southern Telecom, Inc. All rights reserved.
Slick is a registered trademark of Southern Telecom, Inc.
www.slickusa.com

YouTube™ is a registered trademark of YouTube, LLC.
This product is not affiliated with, or endorsed by YouTube™.

ArcSoft and Media Impression are trademarks of ArcSoft, Inc.
The SD logo is a trademark of the SD Card Association.
Other trademarks and trade names are those of their respective owners.

All screen images are simulated.